DESIGN AND DEVELOPMENT OF WRITING ROBOT USING SPEECH PROCESSING

P. Malini¹, A. Akalya², B. Akila³, K. Indhubala⁴, A. Rasiga⁵

¹P. Malini, Assistant Professor, Department of Electronics and Communication Engineering, Vivekanandha College Of Technology for Women, Tamil Nadu, India

^{2,3,4,5}Students, Department of Electronics and Communication Engineering, Vivekanandha College Of Technology for Women, Tamil Nadu, India

DOI: <https://www.doi.org/10.58257/IJPREMS31246>

ABSTARCT

The current educational environment makes it impossible for impaired students to write exams with a scribe, widening the gap between education and disadvantaged students. As a result that huge dropout in schools and college. With speech recognition and robot technology, our suggested method intends to make it easier for such impaired students to take their exams. Our suggested solution is an interactive one that allows students to hear the questions and shout out the responses in a systematic manner. After that, the entire transcript is shipped to the teacher, who then has a robotic arm engrave it on paper. At the conclusion of the test, the student's answer key is made available both in softcopy and hardcopy.

Keywords: Exam, Interactive Systems, Robotic Technology, Speech Processing, and Disabilities.

1. INTRODUCTION

The two most advanced technologies now are voice processing and robotics. The study of speech signals and the techniques used to process them is known as speech processing." Speech processing can be thought of as a particular instance of the Automated Speech Recognition (ASR) digital signal communication interface between humans and machines because it is processed in digital form. Using a broad vocabulary, continuous speech signals can be recognised. The process of turning speech into text is one use of speech processing. It enables interactions between humans and robots when used in conjunction with ASR. Robots are made to assist people and lessen their labour-intensive tasks. Robots today are created to emulate human behaviour and carry out similar jobs as humans. There are a lot of physically disabled people or people with diverse abilities in our society. Many of them are physically armless. Others have suffered from diseases or sad occurrences that have resulted in the loss of limbs or sense organs. They have a significant problem because they are unable to write down their own words. Parents and relatives of children with physical and intellectual disabilities frequently search far and wide for a scribe for exams, especially during exam season. Students with disabilities may feel inferior, dejected, and helpless as a result. Our plan is to make it easier for the blind and other individuals with hand impairments to complete online tests on par with other students. Our project's objective is to create a robotic arm with speech recognition technology that enables people with physical disabilities to communicate responses in writing. The mechanism is set up so that it can help students answer questions by listening to what they say, and then it writes the answers down using a robotic arm and pen. It will be a cheap gadget that might be programmed to let those who have physical limitations write. There are two primary components to the system as proposed. First, the primary portion receives a speech signal and translates it into text; as a result, the second part executes the motor's mechanical action to obtain written responses.

2. LITERATURE SURVEY

Singh et al. demonstrate the operation of a voice-activated device using a Raspberry Pi, the Natural Language Toolkit, and Python. This device could be used for home automation and by people who are blind, but it has the drawback of having a microphone that is unreliable in noisy surroundings.

Milind and Lakshman demonstrated a low-cost device to assist the disabled in writing using an Arduino microcontroller. They employed MATLAB software, Mel's cepstral coefficient, and dynamic time wrapping technology.

R. Balatharangam and colleagues offered the idea that straightforward construction reduces human time and labour. It makes use of the Servo mechanism, Neuro fuzzy control technology, and Microsoft Visual Basic Studio. It cannot write curved letters and is based on trial and error.

Balaganesh et al. suggested a low-cost robotic arm that could demonstrate writing skills using MATLAB software to assist people with writing disabilities. Technology is based on Mel's cepstral coefficient and dynamic time wrapping, and it makes use of MATLAB software, MAX 232 hardware, and PIC16F627A/628A/648A microcontrollers.

Sania Khan et al. developed a system in which the examination is conducted online using interactive speech recognition technology. It makes use of speech synthesis, speech recognition, and the picture matching method known as CBIR (Content-Based Image Retrieval), which is used to match images.

3. SYSTEM ARCHITECTURE:

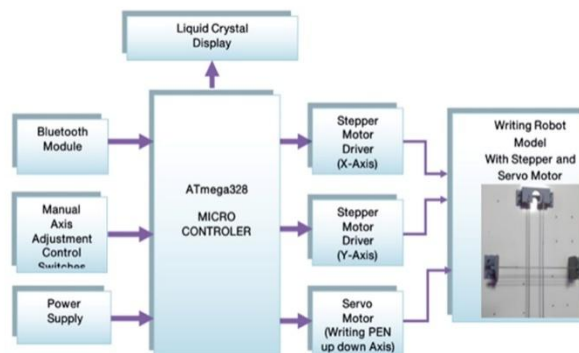

4. FLOW CHART

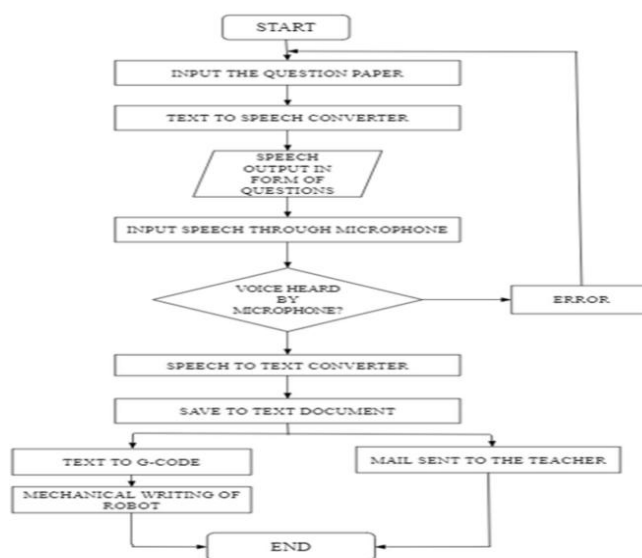

5. PROPOSED MODEL

The proposed model for the design and development of a writing robot using speech processing helps blind people to write the exams on their own like normal people.

5.1 SOFTWARE DEVICE

The software systems used in this system are Embedded C, AVR IDE And Android Application

6. WORKING

The software implementation can be divided into two parts: one is the interactive Q&A, and the other is the student's work being automatically mailed to the teacher. Before the exam begins, the question paper is accepted as input, and after that, the impaired pupils are given a set of earbuds. Through the earbuds, the student taking the test can hear questions as the test begins. The student can shout out the responses after hearing the question, and they will be transformed into text as shown in Fig. 1. Sensor, A to D Converter, AVR IDE, Android Application, and Embedded C Programming are libraries that are used to translate the student's speech into text. The student must enter data to be used by the programme when it runs. The pupil must enter the responses into the computer's microphone before the programme may function. In order to identify the input, the computer compares the words to a database. The learner must reenter their speech; the computer does not recognise any words from the input. The machine determines the right match for a word after identifying the input speech. If the right match cannot be made, the text cannot be formed. The word is transformed into text if the proper match is discovered. The speech (response) can be as long as 60 seconds in total. The student's speech is converted to text by the programme, which then records it in a file. As soon as the student is finished answering, the file is promptly and automatically stored as a text document, delivered to the examiner as shown in Fig. 2, and converted to G-code as necessary for additional hardware implementation.

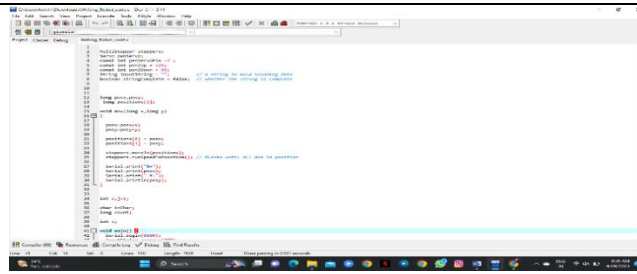

Fig 1. UI For The Examination



Fig 2. File copy To The teacher

6.2 Hardware Devices:The hardware devices used in this system are

7. POWER SUPPLY MODULE

The transformer used in the power supply circuit converts 230 volts to 12 volts. In this circuit, four diodes are used to create a bridge rectifier that produces pulsing dc voltage, which is then sent to a capacitor filter to remove any AC components that may still be present after rectification. This power supply module consists At the mega micro controller, there are pen-moving buttons that can be moved left, right, up, and down; reset buttons; Bluetooth connection; LCD lights; and different colours of wires. There are also two USB cables inserted in this power supply module. While plugging these cables into the switch, one cable will show the red LCD light glowing.

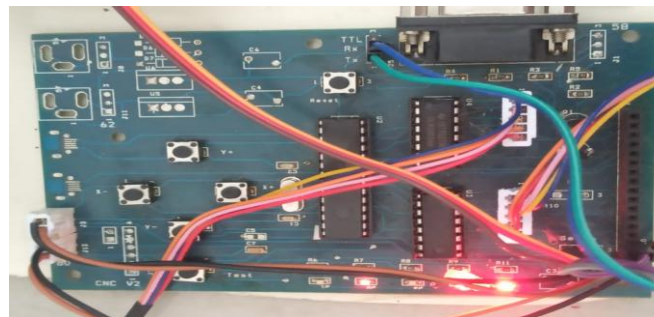

Fig 3. Power Supply Module

Bluetooth Module-It is used in numerous consumer applications, including wireless keyboards, wireless mice, wireless headsets, and game controllers. Here, HC-05 Bluetooth is used in this system.

Hc-05 Bluetooth-The Bluetooth HC-05 module has a wired connection with the power supply module. This module can be set up as either a master or a slave. The red LED on the HC-05 shows if Bluetooth is connected or not as well as the connection status. This red LED continually and irregularly blinks before being connected to the HC-05 module. It blinks for two seconds when it is in Bluetooth range of any other device. This module operates at 3.3 volts. Since there are 5 to 3.3 V regulators built into the module, we can also connect a 5 V supply voltage. Here, a HC-05 Bluetooth module is paired with the mobile, and then it is connected to the app. After connecting with this Bluetooth, only the voice can be recognised.



Fig.4. HC-05 Bluetooth

Servo Motor - A servo motor is an electrical device that can precisely push or spin an object. Use a servo motor if you wish to spin an object at a specified angle or distance. It is only composed of a straightforward motor that uses a servo mechanism. When a motor is employed, it is referred to as a DC servo motor if it is DC powered and an AC servo motor if it is AC powered. A very high-torque servo motor is available in lightweight configurations. These characteristics have led to its employment in a variety of applications, including toy cars, RC helicopters and planes, robotics, machines, etc. In our writing robot project, servo motors are connected to a centre position, which is placed up in the pen stand.



Fig.5.Servo Motor

Stepper Motor -A stepper motor is an electromechanical device that converts electrical power into mechanical power. Also, it is a brushless, synchronous electric motor that can divide a full rotation into an expansive number of steps. The motor's position can be controlled accurately without any feedback mechanism, as long as the motor is carefully sized for the application. Stepper motors are similar to switched-reluctance motors. The stepper motor uses the theory of operation for magnets to make the motor shaft turn a precise distance when a pulse of electricity is provided. The stator has eight poles, and the rotor has six poles. The rotor will require 24 pulses of electricity to move the 24 steps to make one complete revolution. Another way to say this is that the rotor will move precisely 15° for each pulse of electricity that the motor receives.

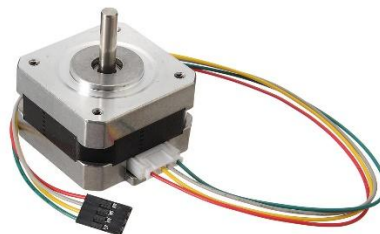

Fig.6. Stepper Motor

Atmega Microcontroller -These single-chip microcontrollers are 8-bit RISC devices with a modified Harvard architecture. As opposed to the one-time programmable ROM, EPROM, or EEPROM used by other microcontroller families at the time, the ATmega was one of the first to use on-chip flash memory for programme storage. It is used for general-purpose purposes, and it has bi-directional I/O ports with multiple functions and programmable built-in pull-up resistors. RC oscillators without external parts are among the numerous internal oscillators. It has internal, 256 KB (384 KB on the X Mega) self-programmable instruction flash memory. Using serial or parallel low-voltage proprietary interfaces, or JTAG, in-system programmable independent lock bits for protection in the optional boot code area Most devices allow on-chip debugging (OCD) via JTAG or debug wire. On GPIOs, the four JTAG signals—TMS, TDI, TDO, and TCK—are multiplexed. Depending on the configuration of a fuse bit, which may be programmed through ISP or HVSP, these pins can be set up to operate as JTAG or GPIO. ATmega with JTAG have the JTAG interface turned on by default. For bi-directional communication with on-chip debug circuitry, WIRE employs the /RESET pin. As it only needs one pin, it can be found on devices with fewer pins. Up to 4 KB of internal data EEPROM. Up to 16 KB of internal SRAM (32 KB on an XMega). On certain models, like the Mega8515 and Mega162, there is an external 64 KB little-endian data space. In order to prevent the entire 64 KB address space from appearing on the external bus and to ensure that visits to addresses like 010016 are made to internal RAM rather than the external bus, the external data space is overlapped with the internal data space.

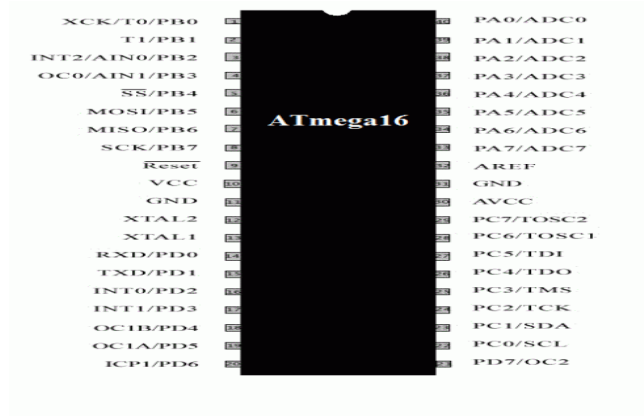

Fig.7. ATmegaMicrocontroller

Axi Draw Machines-Permanent markers and fountain pens are among the writing implements compatible with Axi Draw machines. It is able to write or draw on practically any flat surface because of the machine's distinctive writing head, which extends past the machine's base. This axis consists of an X axis and a Y axis. The paper is inserted under the X axis, and the pen is fitted into the board.

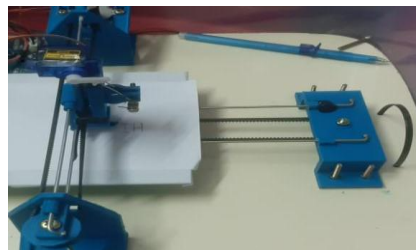

Fig 8. Axi Draw Machines

Working: Any type of text can be written on the writing machine, which is an automatic device. A writing machine operates similarly to a laser engraver. This device has three axes of motion. which are moved by servo and stepper motors on wooden ply. The wooden frame's holes are filled with a stepper motor, a screw, and a pencil. The screw gives the pen its sliding motion. The Y-axis gantry is constructed similarly, and the X and Y gantries are attached. The X gantry has a servo motor attached to it, and a pen is created that is flexible to make the Z axis. Through the A4988 stepper motor driver, the motors are linked to the Arduino Uno and CNC shield. Then we created a ROBOBOY (Robot Arduino Bluetooth Control) app to work with this robot. First, let's click "New Project," and the next page of project control type will be opened. There, we should select the voice symbol, and then we should give the project name and description. Then, it will move to the next page, where it will ask the voice commands. Click "Open Project" to move to the HC-05 Bluetooth Connection, and the next page will be giving voice commands. In this, the machine is used to automatically write the words that are given in the voice command.

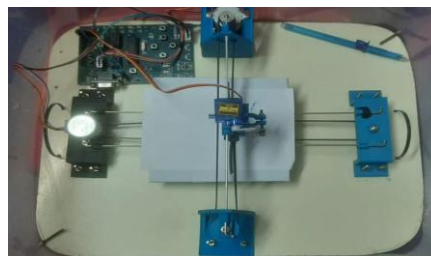

Fig 9. Entire setup of the writing robot



Fig.10. Written form of writing robot

8. RESULTS AND DISCUSSION

Device performance is compared with alternative devices that can give the users by real-time information and work less. A training model was trained to help the physically disabled people or some others who lost their limbs in accidents to write their exams without the help of any other third party. Here we are using a word error rate formula method to identify the error obtained, and the average word error rate should be 21.2%. The hardware system moves through the G code, and then the stepper motor is used to rotate the system. Although the HC-05 Bluetooth can get data from the Android application and send it to the PC through the USB cable, While using this speech processing technology in the writing robot, we can get a result of robot.

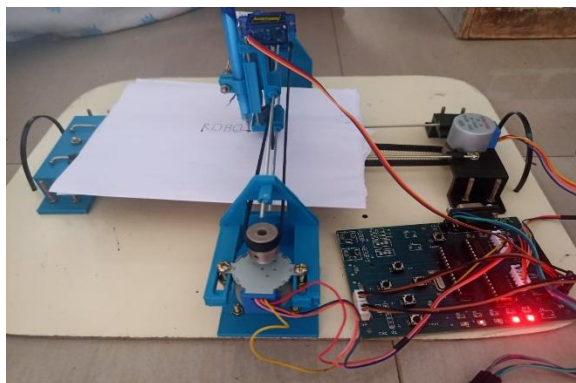

Fig .11. Entire Setup of the writing robot

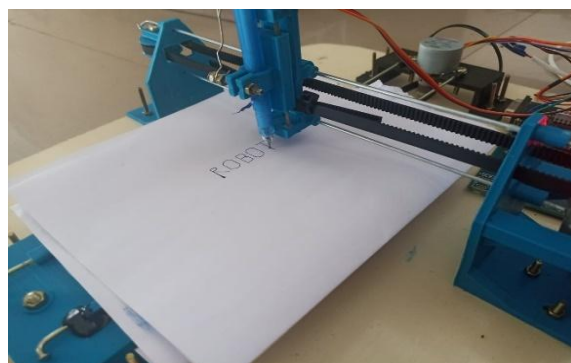

Fig .11. Result of the writing robot

9. CONCLUSION

The purpose of this paper is to assist students who are having trouble writing the examination, and it effectively substitutes the current approach of utilising a third-party scribe by using speech recognition and text-to-writing robots. For students who are physically handicapped, this is a much simpler means of administering exams. Although this can be used for standard written exams, it can also be used for objective exams and non-technical exams that are more theory-based.

10. REFERENCES

- [1] Milind Baviskar, Lakshman Korra, "Speech Based Writing Robotic Arm Using Arduino," IJIRCCE, ISSN: 2320-9801, Vol. 6, Issue 7, July 2020.
- [2] R.Balatharangam, P. Madhu Priya, R.Pavithra, G.Prithviraj, and U.Poornima "Design and development of an Arduino-controlled writing robot" R.B. 2020 , IRJET.
- [3] Siva Dharshini and Sindhuja, "Robotics Speech Recognition and Writing System", International Journal of Electronic And Communication Engineering, IRJET, April 2020.
- [4] J.Jenitta, Durga Prasad. V., and Usha M.M., "Design and Development of Voice-Based Writing Machine for Alphabet," IJMTE. Feb 2021 915.19.2850.
- [5] Sania Khan, Sanskriti Verma, Shweta Agarwal, Prateek Krishnatrey, and Shivam Sharma, "Voice-Based Online Examination for the Physically Challenged", MIT International Journal of Computer Science and Information Technology, Vol. 5, No. 2, August 2022, pp. 58–61.
- [6] M. Balaganesh, E. Sathyabama, "Robotic Arm Showing Writing Skills by Speech Recognition," Collo Marketing, Chennai, India, 2021.